



Auxiliary Table

for the Cross-Cut Sliding Table

PARTS LIST

Ref. No.	Part No.	Description	Qty.
1	516613	Table	1
2	513707	Expansion Bar	1
3	516614	Tapered Pin	2
4	516615	Slotted Nut	2

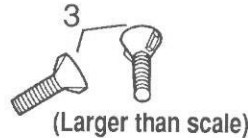
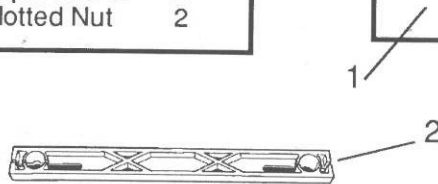
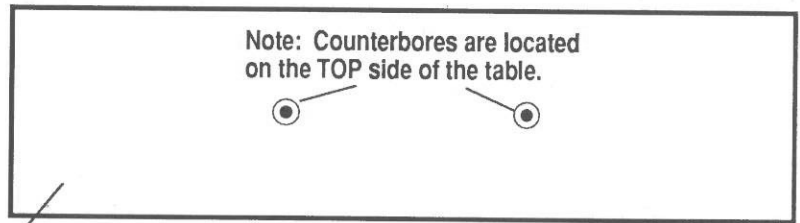

Introduction

The Auxiliary Table for the Cross-Cut Sliding Table is designed to support the board on the left side of the saw blade (the side opposite the Cross-Cut Sliding Table). A board on the left side could fall down and pinch the saw blade if it is not supported at a height equal to the thickness of the Cross-Cut Sliding Table, which is 1/2". This is especially important when you are cutting wood which protrudes 12" or more beyond the left side of the saw blade.

Safety

WARNING

- Read, understand and follow the owner's manual for the Cross-Cut Sliding Table.
- Read, understand and follow the safety and operations sections in the table saw owner's manual.
- Always perform installation and setup of the Auxiliary Table with the table saw turned off, unplugged and with the saw blade well below the table surface. Only expose the saw blade when you are actually operating the table saw.

- Both sides of the stock must always be supported (at the same height) before, during and after the cut.
- Always securely fasten the Auxiliary Table to the worktable before operating the table saw with the Cross-Cut Sliding Table.
- If stock protrudes 12" or more beyond the left side of the saw blade, you must use the Auxiliary Table for the Cross-Cut Sliding Table (or a self-made table of similar proportions), to support wood on the left side of the saw blade while using the Cross-Cut Sliding Table. Failure to do so could cause the cut board to fall down and pinch the saw blade. This could result in damage to equipment and bodily injury.
- If stock protrudes 24" or more beyond the left side of the saw blade, you must use additional support (such as floating tables, fixed extension tables, or roller stands) to support it at the same height plane as the protruding stock.

Assembly

Tool Needed: Medium screwdriver

NOTE

To help you stay oriented correctly for these instructions, the table's TOP side contains the counterbores.

1. Insert both tapered pins (3) into the slotted holes located at each end of the expansion bar (2). The two "ridges" on each pin fit into the slot.

2. Place the tapered pins (3) through the bottom of the table (1), as shown in Fig. 1.

3. On the top side of the table, use a medium screwdriver to attach a slotted nut (4) to each tapered pin (3). See Fig. 2. Do not tighten yet. Fig. 3 shows the assembled Auxiliary Table.

4. Place the Auxiliary Table in the miter gauge slot to the left of the saw blade, as seen in Fig. 4.

5. Use the medium screwdriver to tighten the slotted nuts, as shown in Fig. 5. Be careful not to overtighten.

6. Fig. 6 illustrates the Auxiliary Table set up with the Cross-Cut Sliding Table.

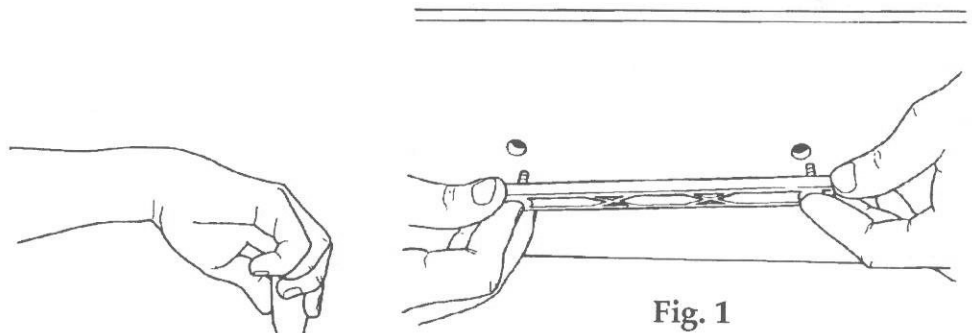

Fig. 1

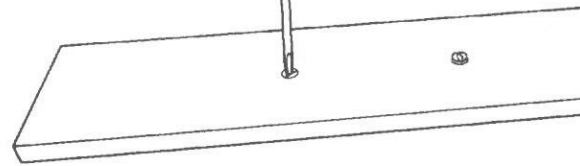

Fig. 2

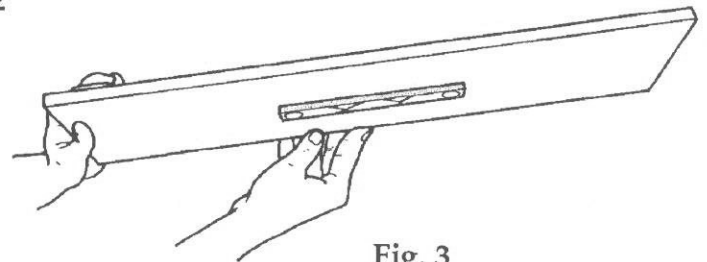

Fig. 3

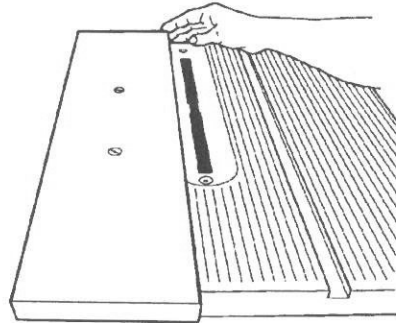

Fig. 4

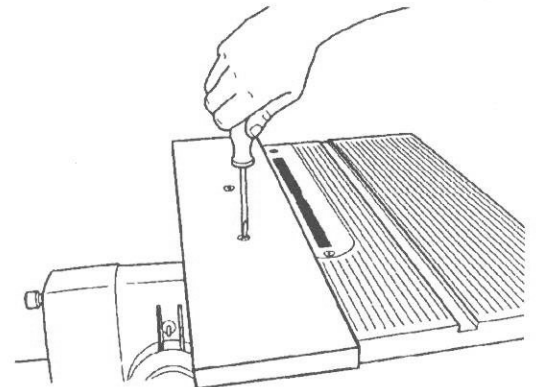

Fig. 5

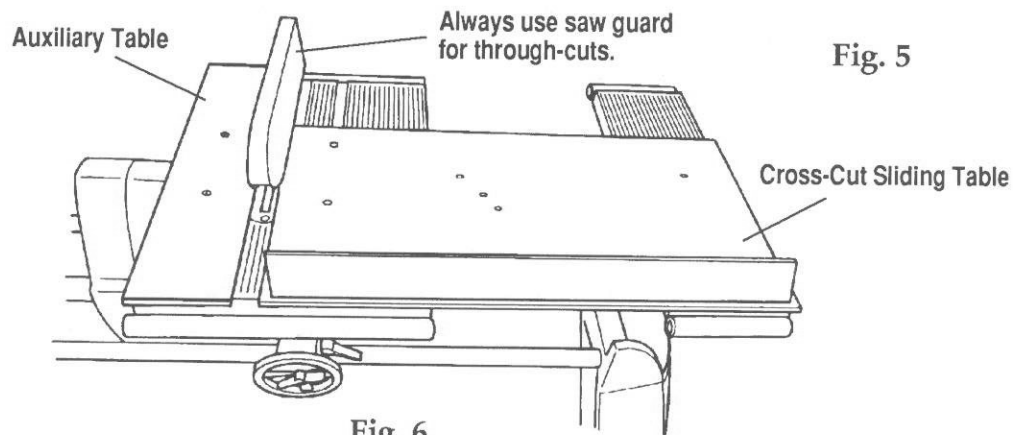

Fig. 6



Shopsmith Inc.
3931 Image Drive
Dayton, Ohio 45414

Note: If you have further questions or need help, visit the Shopsmith Store in your area, or call Customer Service: Toll Free 1-800-762-7555 (in Canada, 1-800-268-3998).

PL-5309 12/90
©1990 Shopsmith, Inc.
All Rights Reserved.
Printed in the U.S.A.